

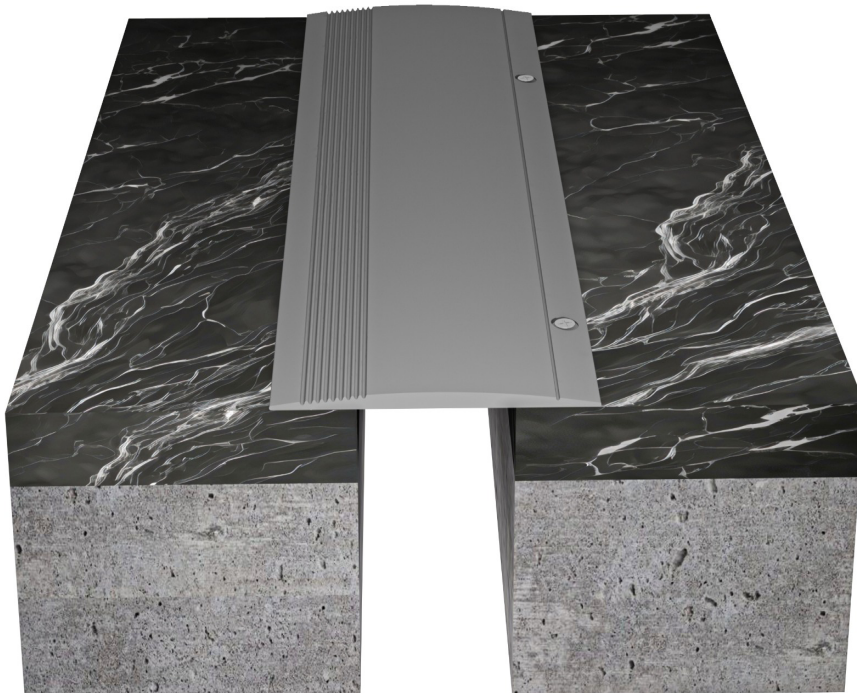

Installation Instructions

i831[®]



Preparation of the Work Area:

1. Please read through entire instructions before installation.
2. Make sure the width and depth of the joint face are 90 ° to the slab's surface.
3. Measure along length of joint to ensure opening is correct size for joint material.
4. Remediate deviations that exceed product tolerances.
5. To ensure successful installation, clean the blockout/joint edge of all contaminants and impurities.

Installation Instructions Steps:

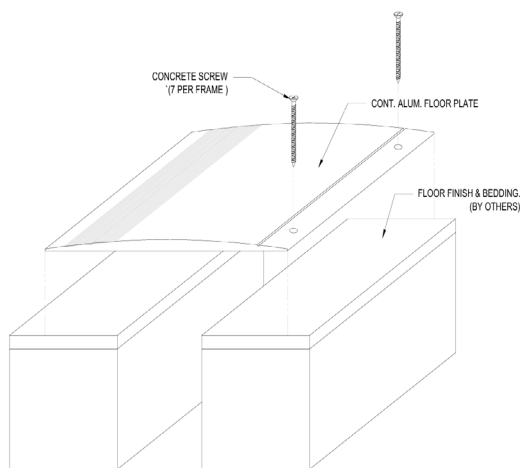

1. Install the architectural joint system on a level finished floor. This may require adding epoxy leveling compound on top of the substrate to provide a smooth mounting surface
2. Cut the aluminum plates to the desired length
3. Place the plate assembly over the structural gap

4. Mark the pre-drilled hole locations on the substrate

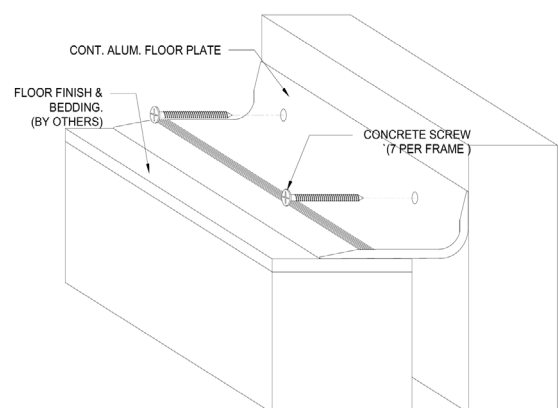

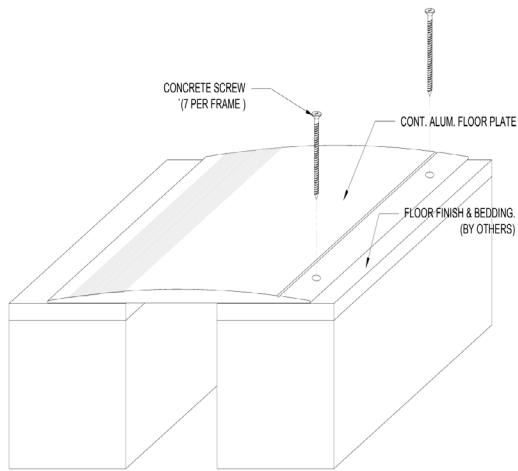

5. Remove the plate assembly
6. Return the plates into position over the drilled hole locations and secure in place with one flat head screw for each anchor

7. Clean the exposed surfaces with a non-solvent cleaner

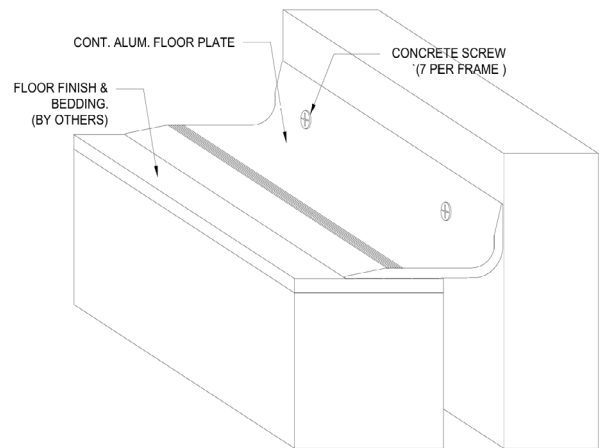
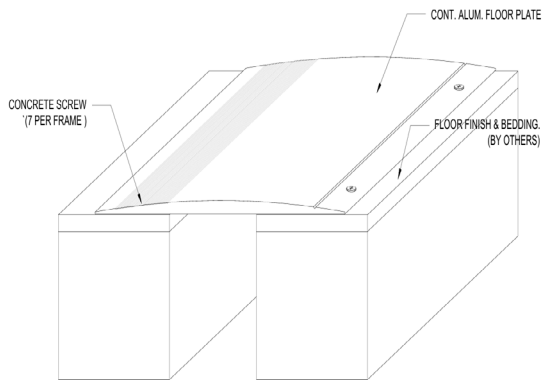

Installation Instructions- January 2024, Version 1.1.5

