

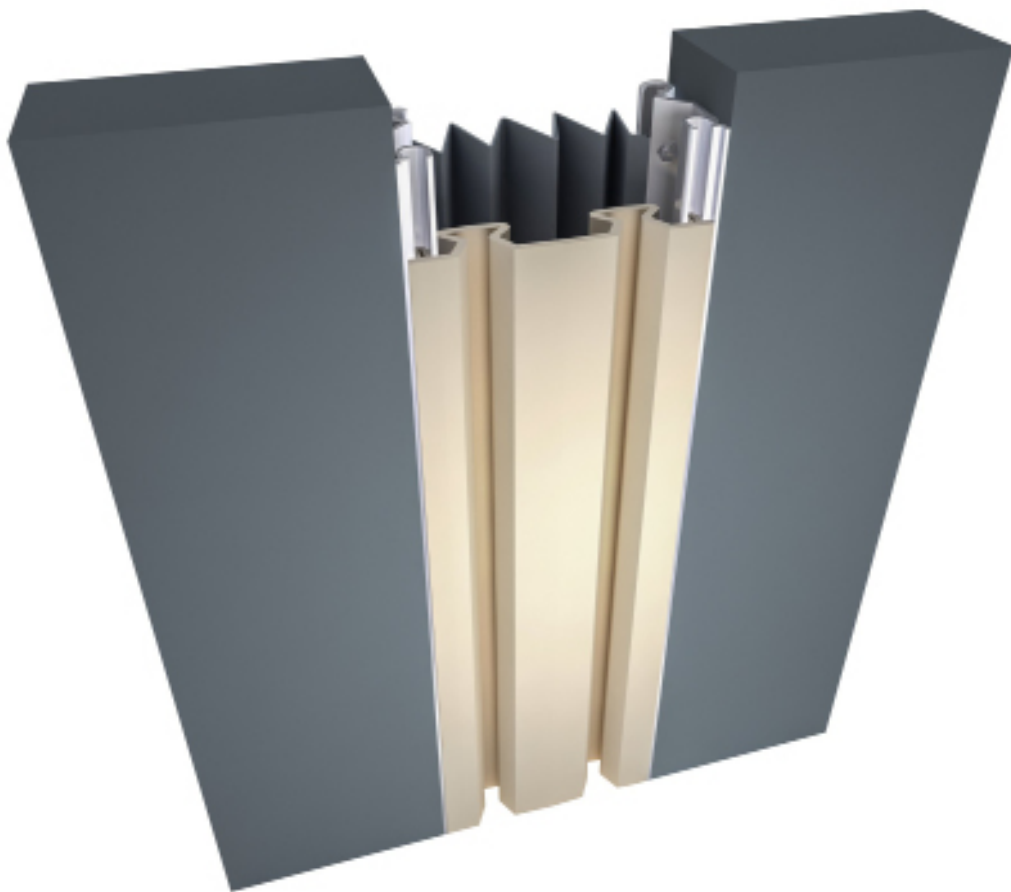

i720[®] Submittal



Flush Mount Exterior Expansion Joints

i720[®]



Description

The i720[®] exterior wall + ceiling expansion joint system is flush mounted to reduce sightline. Additionally, the pleated seal comes in a variety of colors to blend into your wall material.

Key Features

- **Install Condition:** Wall/Wall, Ceiling/Ceiling.
- **Joint width:** 50-150mm.
- Flush mount interior and exterior systems reduce sightline.
- **i900 TR[®]** seals - Field heat weldable for weather tight transitions.
- Standard seal colors: black, beige, gray, off white and bright white. Custom colors available upon request.
- 4 component exterior system includes integral backseal.
- May be installed to various substrates with mechanical anchors or epoxy adhesive.
- Mill finish aluminum.

Materials

Aluminum: Alloy types of 6061-T6, 6063-T6, 6005A, or 5052-H32 sheet goods.

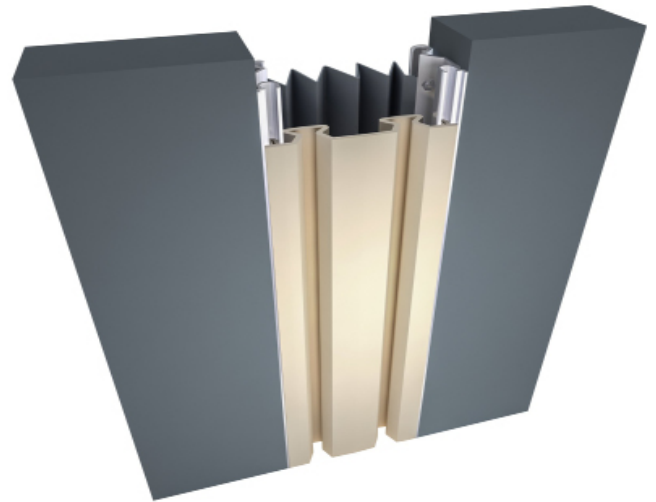

Application Instructions

Installation: Joint systems: Install in accordance with manufacturer's instructions.

Align work plumb, level and flush with adjacent surfaces. Mechanically anchor to substrate. Allowances should be made where actual structural gap at time of installation varies from nominal design gap. No shimming of frames is permitted. Coordinate with work of other Sections.

If concrete blockouts (rebates) are required, ensure continuous support equal to surrounding substrate structural values.

Fire Rated Assemblies: Where required, install to manufacturer's instructions.

Moisture Barrier: Where required, install to manufacturer's instructions.

Flush Mount Exterior Expansion Joints

i720[®]



Protect: the completed Expansion Control system work from damage during construction. Damage protection includes surface abrasion and overloading of coverplate by materials handling equipment and construction waste/debris. Protection from environmental factors required throughout installation process until Project Closeout. Protection includes but is not limited to rain events, moisture protection, exposure to temperature fluctuations or direct sunlight for temperature sensitive product offerings.

Store

Store components in original containers in a clean, dry location. Ensure temperature or moisture sensitive components are stored in a tempered location.

Contractor to provide temporary protective covers on all installed finished surfaces. Protection is required to guard against both surface abrasions as well as overloading of horizontal deck components by construction traffic.

Movement ± 50%

Application	System	W	H1	H2	S	B	Movement +/-		L
		Joint Width	Frame Height 1	Height 2	Sightline	Blockout	Horizontal	Vertical	Load
		mm	mm	mm	mm	mm	mm	mm	Kn
Wall/Wall Ceiling/ Ceiling	i720-50	50	49	*	50	*	25	25	*
	i720-75	75	49	*	75	*	38	38	*
	i720-100	100	49	*	100	*	50	50	*
	i720-125	125	49	*	125	*	63	63	*
	i720-150	150	49	*	150	*	75	75	*
Wall/Corner Wall/Ceiling	i720-C-50	50	49	*	50	*	25	25	*
	i720-C-75	75	49	*	75	*	38	38	*
	i720-C-100	100	49	*	100	*	50	50	*
	i720-C-125	125	49	*	125	*	63	63	*
	i720-C-150	150	49	*	150	*	75	75	*

Wall to Wall or Ceiling to Ceiling
 Wall to Corner or Wall to Ceiling

Flush Mount Exterior Expansion Joints

i720[®]



Series i720

Series i720 - C

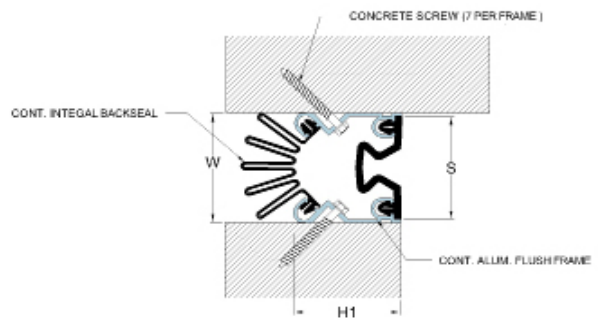
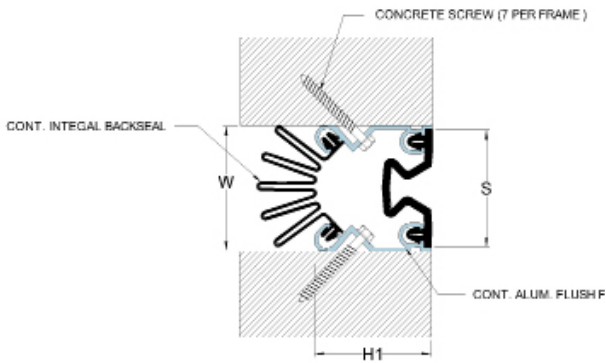

Series i720 - Mineral Wool & Sealant Fire Barrier Options

Series i720 - FireStop S30 Options

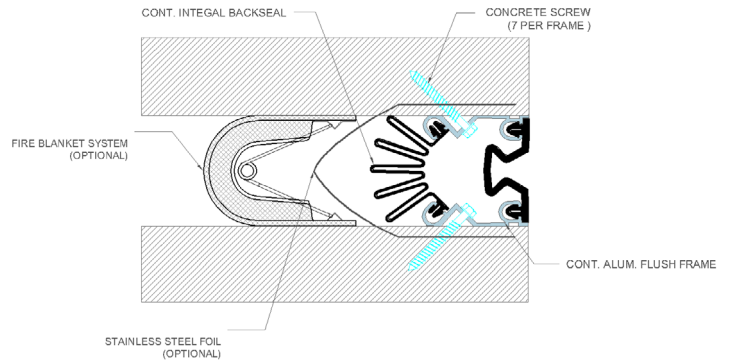
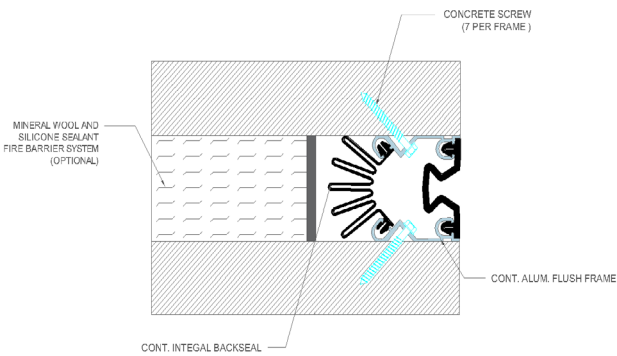





Wall to Wall or Ceiling to Ceiling
Wall to Corner or Wall to Ceiling

Flush Mount Exterior Expansion Joints

i720[®]

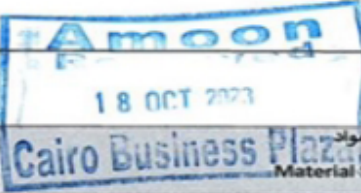

Our Previous Submittals & Approvals

					
		Cairo Business Plaza		Cairo Business Plaza	
Cairo Business Plaza - New Capital Façade A&B : Project Name / اسم المشروع package 2 : اسم / رقم العقد					
Type of work / نوع الأعمال Mech. ELEC Finishing Chill					
HUECK MAX MAX : Contractor / اسم المقاول					
Ref.no / رقم الترخيص : CBP-HUK-MSA-AR-054 Date / تاريخ التقديم : 18/Oct/2023					
Expansion Joints For Building A					
Material / بيان المواد : Name					
Supplier Name / اسم المورد : المتخصص للتجارة والمعاملات Attachments / المرفقات :					
# Exterior Expansion Joints - I 615 - Color Beige					
Description Material / وصف المواد :					
Sample + Data sheet + CD					
Building A : (08900 - 2)					
BOQ Item :					
Building A					
Area of Application / التطبيق :					
Contractor / المقاول :					
Name / الاسم : محمد ابن عبد التيم Signature / التوقيع :		Project Manager / مدير المشروع :		Name / الاسم : محمود عبد العزيز Signature / التوقيع :	
Review Result / نتيجة المراجعة :					
Date Receive / تاريخ الاستلام :					
Receiver / المستلم :					
Evaluation / التقييم :					
D Rejected		C Reject and resubmit		B Approved as noted	
A Approved		Notes / الملاحظات :			
Notes / الملاحظات : - اللهم مظهره لا كلاريفي وللمر لا تظهره للمرأه ودمم ظابع - مع تصحيح SOS في موقع لوجستيا اللهم ودمم ظابع "الخير في ظالمه" هبة					
Project Management / إدارة المشروع :					
CMD / مدير عام الشركة والمقررات		Project Manager / مدير المشروع		MEP Manager / مدير الإنشاءات	
T.O Manager / STD Manager / مدير المكتب الفنية والمقررات مدير المكتب الفنية		Project Management / إدارة المشروع :			
Name / الاسم :		Name / الاسم :		Name / الاسم :	
Signature / التوقيع :		Signature / التوقيع :		Signature / التوقيع :	
Date / التاريخ :		Date / التاريخ :		Date / التاريخ :	
ESP-MSA-Form/Rev.0					
					

Amoon
Received

29 AUG 2023

Cairo Business Plaza

HUECK MakMax
Send

28 AUG 2023

Cairo Business Plaza

HUECK MakMax
Received

14 SEP 2023

Cairo Business Plaza

Material Submittal Report

Cairo Business Plaza - Control Joints

Building Name: Cairo Business Plaza - Control Joints

Project No.: CPJ-HUE-MB-A1-024

Date: 28/Aug/2023

Exterior Expansion Joints - 1 EJS - Color (Black-Gray-Beige)

Material Description: HUECK MAK DMS

Building A: (CB000-1)

Area of Application: Building A

Contractor: [Signature]

Project Manager: [Signature]

Technical Office: [Signature]

D	C	B	A
Rejected	Project and results	Approved as noted	Approved
		<input checked="" type="radio"/>	

Final approval after sample site

O. K.

Project Manager	Site Manager	CD Manager	CD Manager
[Signature]	[Signature]	[Signature]	[Signature]
13-7-23			

CPJ-MSR-Form/Rev.0

1- [Handwritten note]

2- [Handwritten note]

3- [Handwritten note]

