

i720-50

JOINT WIDTH	MOVEMENT +/-	
	HORIZONTAL	VERTICAL
MM	MM	MM
50	25	25



www.iChemEG.com

RIGHTS OF DESIGN

All rights of design, detail, engineering and/or invention contained herein are the property of iChemEG systems corporation and hereby reserved and are not to be reproduced or provided to any other party. iChemEG systems corporation reserve the right to amend or withdraw any information contained herein without notice and will not be liable for any inaccuracy or ambiguity of said information

DATE: 19/02/2024

SCALE: NTS

FINISH: ALUM.FINISH-MILL

PROJECT:

LOCATION:

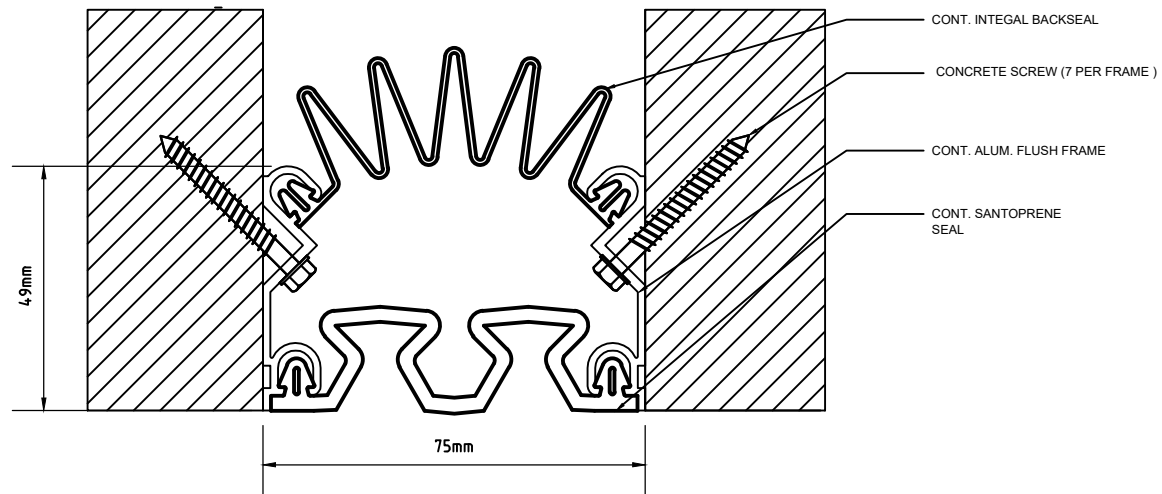

i720-75

JOINT WIDTH	MOVEMENT +/-	
	HORIZONTAL	VERTICAL
MM	MM	MM
75	38	38



www.iChemEG.com

RIGHTS OF DESIGN

All rights of design, detail, engineering and/or invention contained herein are the property of iChemEG systems corporation and hereby reserved and are not to be reproduced or provided to any other party. iChemEG systems corporation reserve the right to amend or withdraw any information contained herein without notice and will not be liable for any inaccuracy or ambiguity of said information

DATE: 19/02/2024

SCALE: NTS

FINISH: ALUM.FINISH-MILL

PROJECT:

LOCATION:

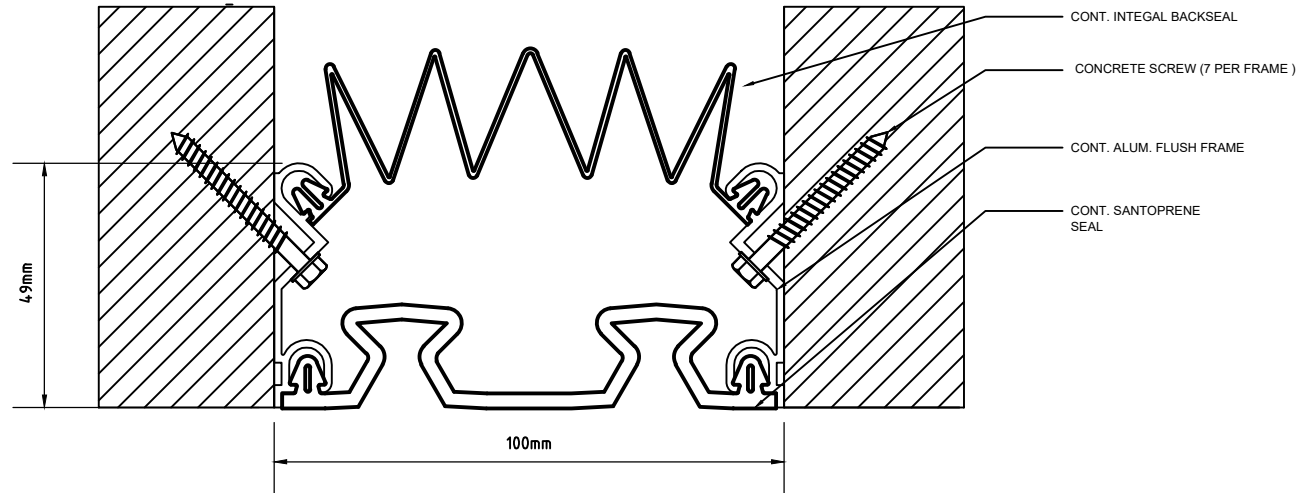

i720-100

JOINT WIDTH	MOVEMENT +/-	
	HORIZONTAL	VERTICAL
MM	MM	MM
100	50	50



www.iChemEG.com

RIGHTS OF DESIGN

All rights of design, detail, engineering and/or invention contained herein are the property of iChemEG systems corporation and hereby reserved and are not to be reproduced or provided to any other party. iChemEG systems corporation reserve the right to amend or withdraw any information contained herein without notice and will not be liable for any inaccuracy or ambiguity of said information

DATE: 19/02/2024

SCALE: NTS

FINISH: ALUM.FINISH-MILL

PROJECT:

LOCATION:

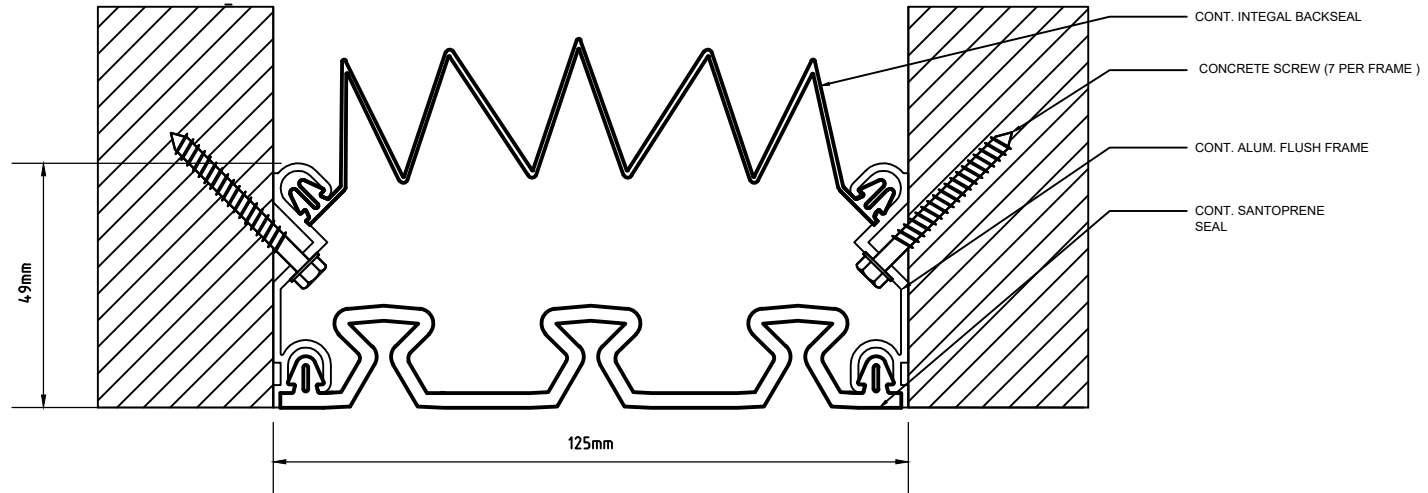

i720-125

JOINT WIDTH	MOVEMENT +/-	
	HORIZONTAL	VERTICAL
MM	MM	MM
125	63	63



www.iChemEG.com

RIGHTS OF DESIGN

All rights of design, detail, engineering and/or invention contained herein are the property of iChemEG systems corporation and hereby reserved and are not to be reproduced or provided to any other party. iChemEG systems corporation reserve the right to amend or withdraw any information contained herein without notice and will not be liable for any inaccuracy or ambiguity of said information

DATE: 19/02/2024

SCALE: NTS

FINISH: ALUM.FINISH-MILL

PROJECT:

LOCATION:

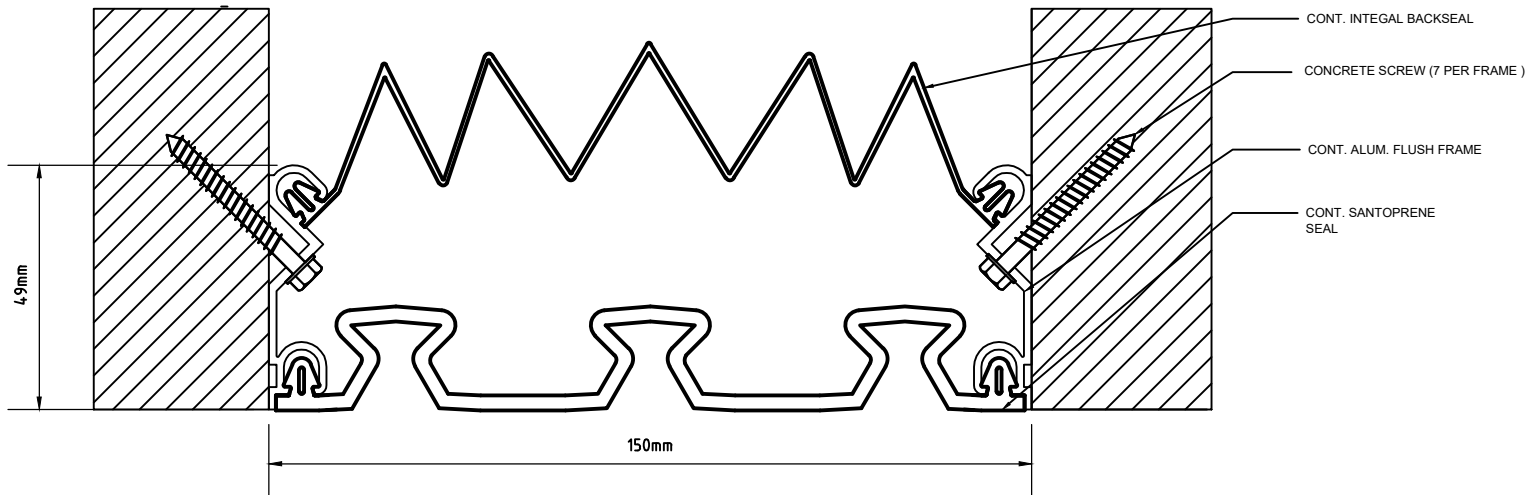

i720-150

JOINT WIDTH	MOVEMENT +/-	
	HORIZONTAL	VERTICAL
MM	MM	MM
150	75	75



www.iChemEG.com

RIGHTS OF DESIGN

All rights of design, detail, engineering and/or invention contained herein are the property of iChemEG systems corporation and hereby reserved and are not to be reproduced or provided to any other party. iChemEG systems corporation reserve the right to amend or withdraw any information contained herein without notice and will not be liable for any inaccuracy or ambiguity of said information

DATE: 19/02/2024

SCALE: NTS

FINISH: ALUM.FINISH-MILL

PROJECT:

LOCATION: