

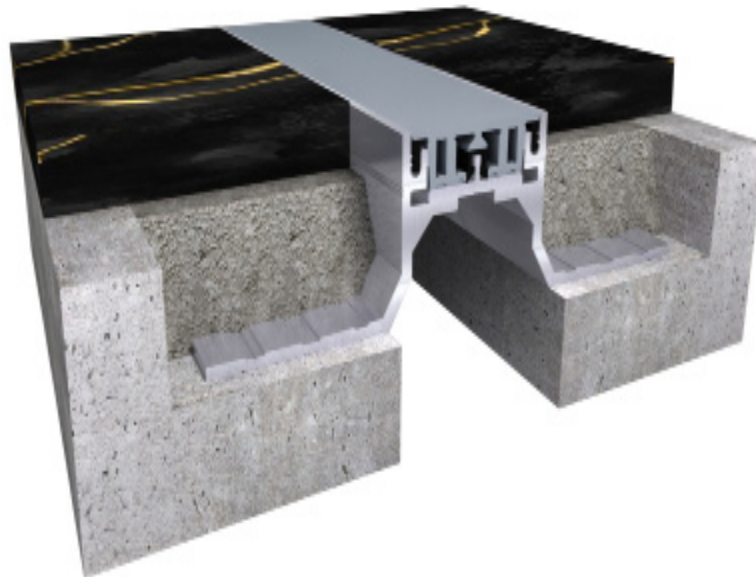

Installation Instructions

i330[®]



Preparation of The Work Area:

- Please read through entire instructions before installation.
- Make sure the width and depth of the joint face are 90 to the slab's surface.
- Measure along length of joint to ensure opening is correct size for joint material.
- Remediate deviations that exceed product tolerances.
- To ensure successful installation, clean the joint edge of all contaminants and impurities.

Installation Instructions Steps:

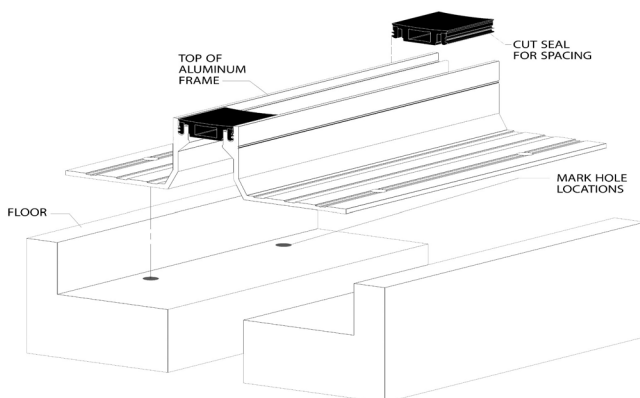

1. Install the architectural joint system on a level surface within the blockout. To determine blockout depth, deduct thickness of floor finish from frame height. Make sure top of frame is level with the finished floor height. This may require adding leveling compound to raise the tops of the frames

2. Cut the aluminum frames to the desired length
3. Center the frames over the structural gap and drop into recess
4. For floor to wall system, make sure aluminum wall frame is firmly located against the finished wall. The top of the precut spacer should be level with the height of the finished floor
5. Mark the pre-drilled hole locations on the substrate
6. Remove the frame assembly from the blockout

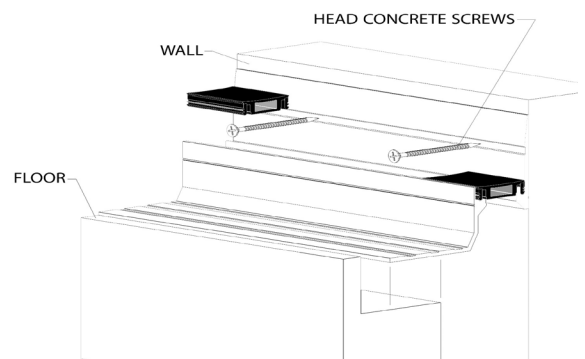

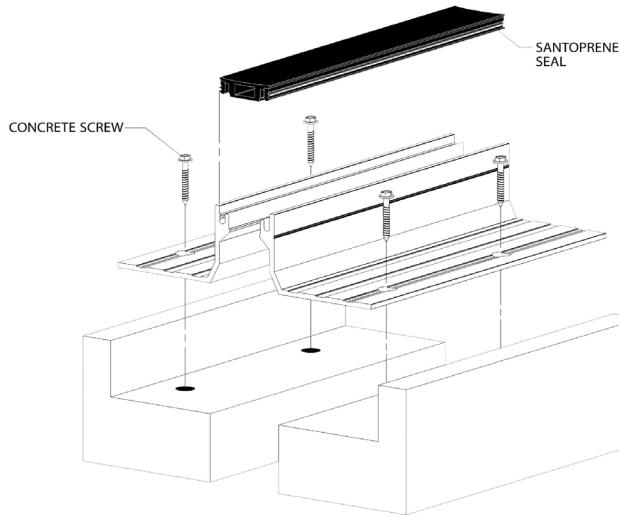

7. Drill all marked holes
8. Return the frames into position over the drilled hole locations
9. Insert the Santoprene seal into the recessed frame slots until the seal is flush with the tops of the frames

10. Backfill the blockout and install the floor finish level to the top of the frame
11. Clean the exposed surfaces with a non-solvent cleaner

